

Cutting Tools



I01-I40

I01~28
Fast Drill

68000 I01



68010 I01



68020 I02



68030 I02



68040 I03



68050 I04



68060 I05



68070 I06



68080 I07



68090 I08



68100 I09



68110 I10



68120 I11



68130 I12



68140 I15



68150 I17



68160 I19



68170 I21



68180 I23



68190 I24



68210 I25



68220 I26

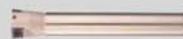

68230 I27



68240 I28

I29~40
Face End Mill

68250 I29



68280 I30



68290 I30



68300 I31



68310 I32



68320 I33



68330 I34



68340 I34



68350 I35



68370 I36



68390 I37



68400 I38



68410 I39



68420 I40

Deburring Tool

67000

RG1000

NOGA MULTIBURR SET



S10 Blade

67000-01 BS1010

Works best on steel, aluminum and plastic.

D50 Scraper Blade

67000-02 BD5010

Ideal for tool and die makers

Opening lever

A single spring lock will release and close all the tools.

N2 Blade

67000-03 BN2010

Works best on brass and cast iron.

Rotodrive Countersink Blade

67000-04 BC1041

Quickest way to chamfer.

Range: 1-10.4mm

Each tool has a separate lever which enables the opening of the unit.

Applications:

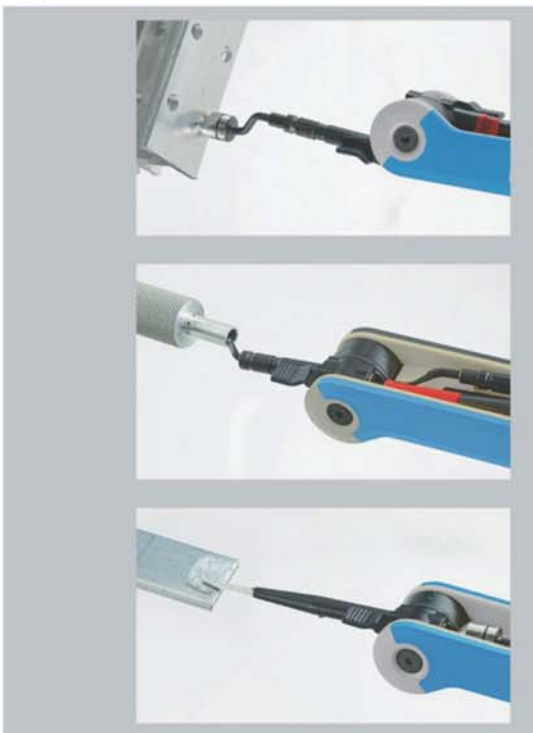

MULTIBURR

RG1000

The handy universal deburring set with multipurpose blades will help you produce a perfect finish for wide variety of jobs.

This innovative tool set has 4 folding shafts which can be easily locked into position for the duration of the work and then folded neatly back into the handle allowing the tool to be carried simply anywhere.

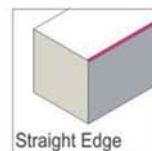

Straight Edge



Bushing Scraping

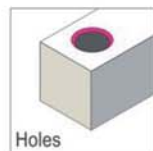

Holes

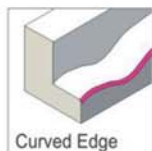

Curved Edge

Demostration for Deburring Systems

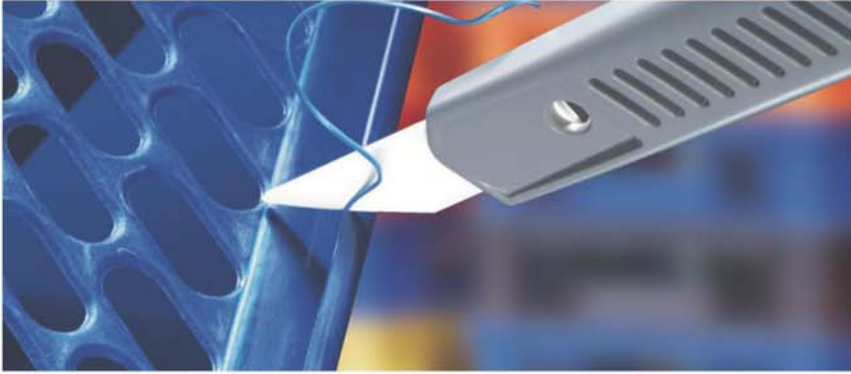

DEBURRING TOOL

Deburring Tool

67010 NG1910 >> NOGA Non Scratch



Non Scratch

NG1910 Tool with non scratch blade with safety cap
Removing burrs from workpieces may sometimes leave unsightly scratches, Noga's NG-1 handle with the NEW non scratch blade with safety cap will prevent friction therefore eliminating scratches. Works best on steel, aluminum



INCLUDES:

NG1000 NG-1 Handle



67012 NG1000 >>

BS9110 Non scratch HSS Blade with safety cap
Plastic safety cap will protect workpiece surface from scratches

67014 BS9110 >>



DEBURRING TOOL

67020

CR1500

Mini Ceramic Handle and Convexed Blade

Ceramic Tool

CR1500 Mini Ceramic Handle and Convexed Blade

A unique mini plastic handle and convexed ceramic blade, perfect for plastic materials and soft metals. Ideal for surface scraping and parting line deflashing.

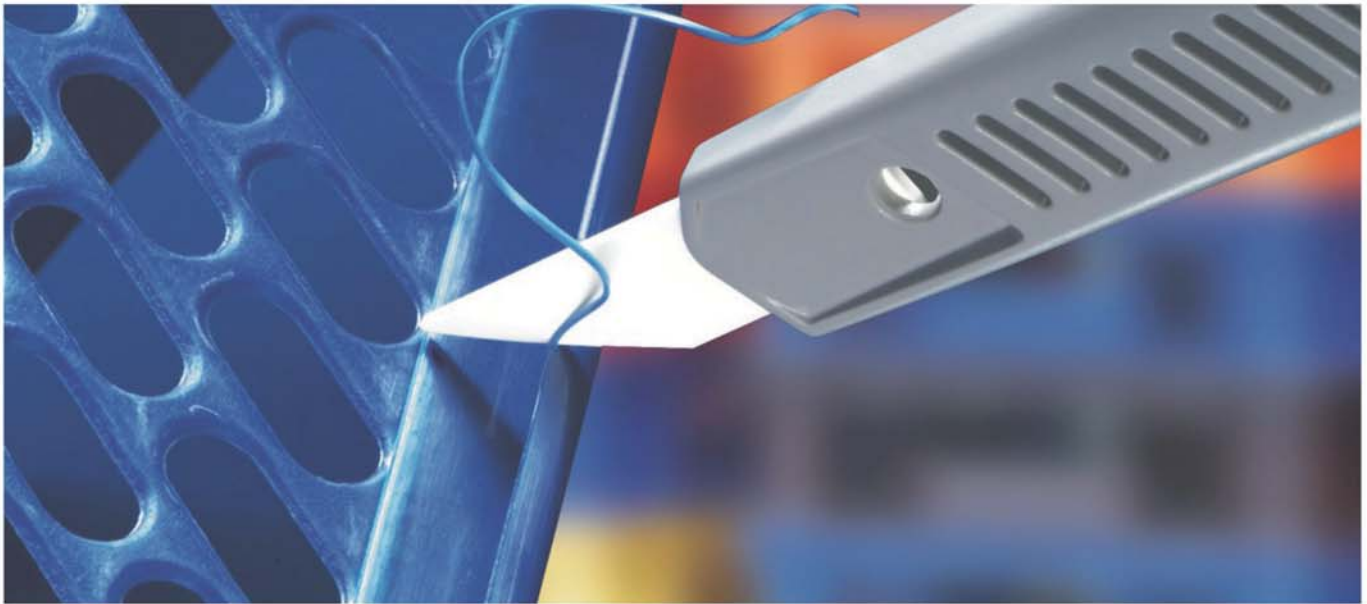

67022

CR1400

INCLUDES:

CR1400 Mini Handle

A unique plastic handle that holds blade by its self-gripping taper. Storage space for spare blades.



67024

CR1550

CR1550 Mini Ceramic Convexed Blade

surface cleaning, trimming on small parts deburring and parting line deflashing.

To remove blade

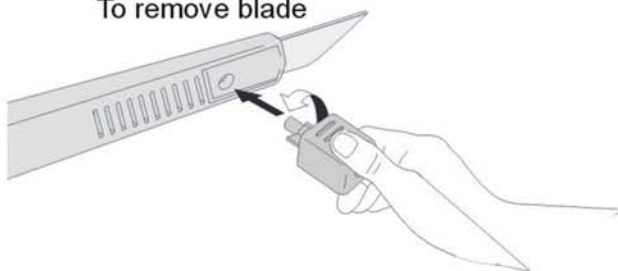

To insert blade

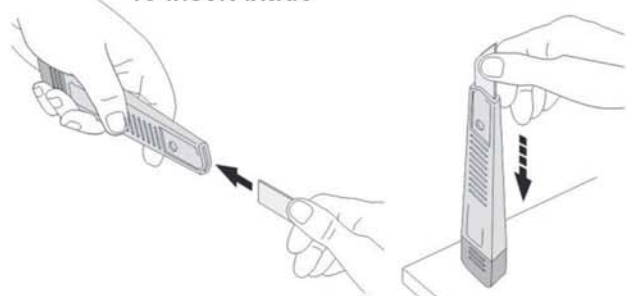

Deburring Tool

67030 CR4100 Adjustable Ceramic Mini Scraper

Ceramic Tool

CR4100 Adjustable Ceramic Mini Scraper

Ceramic mini scraper ideal for surface cleaning, trimming deburring and parting line deflashing on most plastics. Special blade design for safety.



67032 YT10004

INCLUDES:

YT10004 Mini Scraper Handle

The perfect grip for adjustable ceramic mini scrapers



67034 CR4500

CR4500 Ceramic Convexed Blade

Fine ceramic mini-scraper blade

Spec: 4x50mm



DEBURRING TOOL

67040

FT3000

NOGA Micro Deburring Set



FT3000 Noga Micro Deburring Set
A set containing Noga three micro tools
Ideal for Tool and Die maker for extra
fine jobs.

INCLUDES:
FT10001-S150 blade
FT11001-D50 scraper blade.
FT12001-3.2mm countersink blade
(Blades are not replaceable)



67041

FT10001

FT10001-S150 blade

A tool with finest HSS blade S150 for extra fine jobs.



67042

FT11001

FT11001-D50 Scraper blade

Fine triangular Hss mini-scraper ideal for Tool and Die
maker.



67043

FT12001







FT12001-3.2mm countersink blade

Deburs and Countersinks small holes 0-3mm







Cutting Tool

RAPID DRILL FEATURES

	Content	WDX RAPID DRILL
Tools	Material	SKD61, Durable and stable
	Facility	5 axis machining, high quality and accuracy.
Inserts	Brand	SUMITOMO
	Types	Quadrangle
	Flutes	4 flutes (Center flutes x 2, side flutes x 2)
	Workpieces	Depending on workpieces
Drilling Performance	Workpiece Bottom	Almost flat
	Chip removal SS400 Coolant through	Slices
	Insert Lifecycle	Excellent
	Efficiency	Excellent
	CNC Lathe	●
	CNC Milling	●
	CNC Eccentric Lathe	●
	 Flat Drilling	●
	 Tilt Drilling	●
	 Convex Drilling	●
	 Concave Drilling	●
	 Cross Drilling	●
	 Fish Eye Drilling	●
	 Side Drilling	●

If it is with coolant through design, it will be more effective.

L	G	H	G-DL1500
			
Slow feed, used for cutting	General type	Strong flutes for high rigidity	For aluminum

Insert Material	Workpieces
ACP300	P (General cutting) M
ACK300	P (High speed cutting) K
DL1500	N

Capability of inserts in cutting.

Recommend	Model	Workpieces	Features
Priority	G-ACP300	P M	Normal steel, alloy steel, stainless steel
	G-ACK300	P K	Casting Iron or normal steel, alloy steel, stainless steel.
	G-DL1500	N	For non-metal and aluminum
Second	L-ACP300	P M	SS400,SCM415,SCM440...
	L-ACK300	P K	Low carbon alloy steel wear resistance than with
	H-ACP300	P K	For high rigid or non-continuous cutting.
	H-ACK300	K	For high rigid or non-continuous cutting.



Cutting Tool

68140

WDX-2D

Rapid Drill (2D)

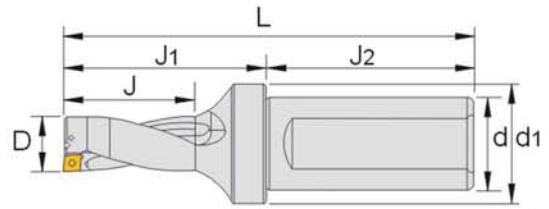

90° Unit:mm

Order No.	Model	D	L	J	J1	J2	d	d1	Deviation	Inserts	Wrench	Screw
68140-01	WDX13 -C25-2D-26L	13	106	26	50	56	25		0.35	WDXT042004	T6	M1.8-3.0-2.4-60
68140-02	WDX13.5-C25-2D-28L	13.5	106	27	50	56	25		0.30			
68140-03	WDX14 -C25-2D-28L	14	108	28	52	56	25		0.25			
68140-04	WDX14.5-C25-2D-30L	14.5	108	29	52	56	25		0.20			
68140-05	WDX15 -C25-2D-30L	15	110	30	54	56	25		0.15			
68140-06	WDX15.5-C25-2D-32L	15.5	110	31	54	56	25		0.40	WDXT052504	T6	M2.0-5.0-2.7-60
68140-07	WDX16 -C25-2D-32L	16	112	32	56	56	25		0.40			
68140-08	WDX16.5-C25-2D-34L	16.5	112	33	56	56	25		0.35			
68140-09	WDX17 -C25-2D-34L	17	114	34	58	56	25		0.30			
68140-10	WDX17.5-C25-2D-36L	17.5	114	35	58	56	25		0.25			
68140-11	WDX18 -C25-2D-36L	18	116	36	60	56	25		0.20	WDXT063006	T7	M2.2-5.5-3.4-60
68140-12	WDX18.5-C25-2D-38L	18.5	116	37	60	56	25	32	0.50			
68140-13	WDX19 -C25-2D-38L	19	118	38	62	56	25		0.45			
68140-14	WDX19.5-C25-2D-40L	19.5	118	39	62	56	25		0.40			
68140-15	WDX20 -C25-2D-40L	20	120	40	64	56	25		0.30			
68140-16	WDX20.5-C25-2D-42L	20.5	120	41	64	56	25		0.30	WDXT073506	T8	M2.5-6.0-3.5-60
68140-17	WDX21 -C25-2D-42L	21	122	42	66	56	25		0.20			
68140-18	WDX21.5-C25-2D-44L	21.5	122	43	66	56	25		0.15			
68140-19	WDX22 -C25-2D-44L	22	124	44	68	56	25		0.10			
68140-20	WDX22.5-C25-2D-46L	22.5	124	45	68	56	25		0.05			
68140-21	WDX23 -C25-2D-46L	23	126	46	70	56	25		0.70	WDXT073506	T8	M2.5-6.0-3.5-60
68140-22	WDX23.5-C32-2D-47L	23.5	130	47	70	60	32	38.5	0.70			
68140-23	WDX24 -C32-2D-48L	24	132	48	72	60	32		0.60			
68140-24	WDX24.5-C32-2D-50L	24.5	132	49	72	60	32		0.50			
68140-25	WDX25 -C32-2D-50L	25	134	50	74	60	32		0.50			
68140-26	WDX25.5-C32-2D-52L	25.5	134	51	74	60	32		0.45			
68140-27	WDX26 -C32-2D-52L	26	141	52	81	60	32		0.40			
68140-28	WDX26.5-C32-2D-54L	26.5	141	53	81	60	32		0.35			
68140-29	WDX27 -C32-2D-54L	27	143	54	83	60	32		0.25			
68140-30	WDX27.5-C32-2D-56L	27.5	143	55	83	60	32		0.20			
68140-31	WDX28 -C32-2D-56L	28	145	56	85	60	32		0.15			
68140-32	WDX28.5-C32-2D-58L	28.5	145	57	85	60	32		0.10			

CUTTING TOOL

Unit:mm

Order No.	Model	D	L	J	J1	J2	d	d1	Deviation	Inserts	Wrench	Screw
68140-33	WDX29 -C32-2D-58L	29	147	58	87	60	32	39	1.00	WDXT094008	T15	M3.5-8.0-5.3-60
68140-34	WDX29.5-C32-2D-60L	29.5	147	59	87	60	32		0.95			
68140-35	WDX30 -C32-2D-60L	30	149	60	89	60	32	0.90				
68140-36	WDX31 -C32-2D-62L	31	151	62	91	60	32	0.80				
68140-37	WDX32 -C32-2D-64L	32	153	64	93	60	32	0.70				
68140-38	WDX33 -C32-2D-66L	33	155	66	95	60	32	0.55				
68140-39	WDX34 -C32-2D-68L	34	157	68	97	60	32	0.45				
68140-40	WDX35 -C32-2D-70L	35	159	70	99	60	32	0.35				
68140-41	WDX36 -C32-2D-72L	36	161	72	101	60	32	0.20				
68140-42	WDX37 -C32-2D-74L	37	163	74	103	60	32	1.00	WDXT125012			
68140-43	WDX38 -C32-2D-76L	38	165	76	105	60	32	1.00				
68140-44	WDX39 -C32-2D-78L	39	167	78	107	60	32	0.90				
68140-45	WDX40 -C40-2D-80L	40	179	80	109	70	40	0.80				
68140-46	WDX41 -C40-2D-82L	41	181	82	111	70	40	0.70				
68140-47	WDX42 -C40-2D-84L	42	183	84	113	70	40	0.60				
68140-48	WDX43 -C40-2D-86L	43	185	86	115	70	40	0.50				
68140-49	WDX44 -C40-2D-88L	44	187	88	117	70	40	0.50				
68140-50	WDX45 -C40-2D-90L	45	189	90	119	70	40	0.40				
68140-51	WDX46 -C40-2D-92L	46	197	92	127	70	40	1.50		WDXT156012	T25	M6.0-15.0-9.0-60
68140-52	WDX47 -C40-2D-94L	47	199	94	129	70	40	1.40				
68140-53	WDX48 -C40-2D-96L	48	201	96	131	70	40	1.30				
68140-54	WDX49 -C40-2D-98L	49	203	98	133	70	40	1.20				
68140-55	WDX50 -C40-2D-100L	50	205	100	135	70	40	1.10				
68140-56	WDX51 -C40-2D-102L	51	207	102	137	70	40	1.00				
68140-57	WDX52 -C40-2D-104L	52	209	104	139	70	40	0.90				
68140-58	WDX53 -C40-2D-106L	53	211	106	141	70	40	0.80				
68140-59	WDX54 -C40-2D-108L	54	213	108	143	70	40	0.60				
68140-60	WDX55 -C40-2D-110L	55	215	110	145	70	40	0.50				
68140-61	WDX56 -C40-2D-112L	56	220	112	150	70	40	2.00	WDXT186012	T25	M6.0-15.0-9.0-60	
68140-62	WDX57 -C40-2D-114L	57	222	114	152	70	40	1.80				
68140-63	WDX58 -C40-2D-116L	58	224	116	154	70	40	1.70				
68140-64	WDX59 -C40-2D-118L	59	226	118	156	70	40	1.60				
68140-65	WDX60 -C40-2D-120L	60	228	120	158	70	40	1.50				
68140-66	WDX61 -C40-2D-122L	61	230	122	160	70	40	1.40				
68140-67	WDX62 -C40-2D-124L	62	232	124	162	70	40	1.30				
68140-68	WDX63 -C40-2D-126L	63	234	126	164	70	40	1.20				
68140-69	WDX64 -C40-2D-128L	64	236	128	166	70	40	1.00				
68140-70	WDX65 -C40-2D-130L	65	238	130	168	70	40	0.90				
68140-71	WDX66 -C40-2D-132L	66	240	132	170	70	40	0.70				
68140-72	WDX67 -C40-2D-134L	67	242	134	172	70	40	0.60				
68140-73	WDX68 -C40-2D-136L	68	244	136	174	70	40	0.50				



CUTTING TOOL

Cutting Tool

68150

WDX-3D

Rapid Drill (3D)

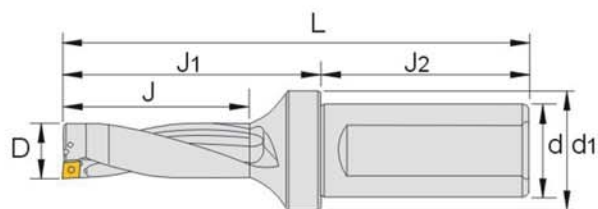

90° Unit:mm

Order No.	Model	D	L	J	J1	J2	d	d1	Deviation	Inserts	Wrench	Screw	
68150-01	WDX13 -C25-3D-39L	13	119	39	63	56	25	32	0.35	WDXT042004	T6	M1.8-3.0-2.4-60	
68150-02	WDX13.5-C25-3D-40.5L	13.5	119	40.5	63	56	25		0.30				
68150-03	WDX14 -C25-3D-42L	14	122	42	66	56	25		0.25				
68150-04	WDX14.5-C25-3D-43.5L	14.5	122	43.5	66	56	25		0.20				
68150-05	WDX15 -C25-3D-45L	15	125	45	69	56	25		0.15				
68150-06	WDX15.5-C25-3D-46.5L	15.5	125	46.5	69	56	25		0.40	WDXT052504	T6	M2.0-5.0-2.7-60	
68150-07	WDX16 -C25-3D-48L	16	128	48	72	56	25		0.40				
68150-08	WDX16.5-C25-3D-49.5L	16.5	128	49.5	72	56	25		0.35				
68150-09	WDX17 -C25-3D-51L	17	131	51	75	56	25		0.30				
68150-10	WDX17.5-C25-3D-52.5L	17.5	131	52.5	75	56	25		0.25				
68150-11	WDX18 -C25-3D-54L	18	134	54	78	56	25		0.20	WDXT063006	T7	M2.2-5.5-3.4-60	
68150-12	WDX18.5-C25-3D-55.5L	18.5	134	55.5	78	56	25		0.50				
68150-13	WDX19 -C25-3D-57L	19	137	57	81	56	25		0.45				
68150-14	WDX19.5-C25-3D-58.5L	19.5	137	58.5	81	56	25		0.40				
68150-15	WDX20 -C25-3D-60L	20	140	60	84	56	25		0.30				
68150-16	WDX20.5-C25-3D-61.5L	20.5	140	61.5	84	56	25		0.30	WDXT073506	T8	M2.5-6.0-3.5-60	
68150-17	WDX21 -C25-3D-63L	21	143	63	87	56	25		0.20				
68150-18	WDX21.5-C25-3D-64.5L	21.5	143	64.5	87	56	25		0.15				
68150-19	WDX22 -C25-3D-66L	22	146	66	90	56	25		0.10				
68150-20	WDX22.5-C25-3D-67.5L	22.5	146	67.5	90	56	25		0.05				
68150-21	WDX23 -C25-3D-69L	23	149	69	93	56	25		0.70	38.5	WDXT073506	T8	M2.5-6.0-3.5-60
68150-22	WDX23.5-C32-3D-70.5L	23.5	149	70.5	93	60	32		0.70				
68150-23	WDX24 -C32-3D-72L	24	156	72	96	60	32		0.60				
68150-24	WDX24.5-C32-3D-73.5L	24.5	156	73.5	96	60	32		0.50				
68150-25	WDX25 -C32-3D-75L	25	159	75	99	60	32		0.50				
68150-26	WDX25.5-C32-3D-76.5L	25.5	159	76.5	99	60	32		0.45				
68150-27	WDX26 -C32-3D-78L	26	167	78	107	60	32		0.40				
68150-28	WDX26.5-C32-3D-79.5L	26.5	167	79.5	107	60	32		0.35				
68150-29	WDX27 -C32-3D-81L	27	170	81	110	60	32		0.25				
68150-30	WDX27.5-C32-3D-82.5L	27.5	170	82.5	110	60	32		0.20				
68150-31	WDX28 -C32-3D-84L	28	173	84	113	60	32		0.15				
68150-32	WDX28.5-C32-3D-85.5L	28.5	173	85.5	113	60	32		0.10				

Unit:mm

Order No.	Model	D	L	J	J1	J2	d	d1	Deviation	Inserts	Wrench	Screw
68150-33	WDX29 -C32-3D-87L	29	176	87	116	60	32	38.5	1.00	WDX094008	T15	M3.5-8.0-5.3-60
68150-34	WDX29.5-C32-3D-88.5L	29.5	176	88.5	119	60	32		0.95			
68150-35	WDX30 -C32-3D-90L	30	179	90	119	60	32		0.90			
68150-36	WDX31 -C32-3D-93L	31	182	93	122	60	32		0.80			
68150-37	WDX32 -C32-3D-96L	32	185	96	125	60	32		0.70			
68150-38	WDX33 -C32-3D-99L	33	188	99	128	60	32		0.55			
68150-39	WDX34 -C32-3D-102L	34	191	102	131	60	32		0.45			
68150-40	WDX35 -C32-3D-105L	35	194	105	134	60	32		0.35			
68150-41	WDX36 -C32-3D-108L	36	197	108	137	60	32		0.20			
68150-42	WDX37 -C32-3D-111L	37	200	111	140	60	32		1.00			
68150-43	WDX38 -C32-3D-114L	38	203	114	143	60	32	1.00	WDX125012	T20	M5.0-11.0-7.0-60	
68150-44	WDX39 -C32-3D-117L	39	206	117	146	60	32	0.90				
68150-45	WDX40 -C40-3D-120L	40	219	120	149	70	40	0.80				
68150-46	WDX41 -C40-3D-123L	41	222	123	152	70	40	0.70				
68150-47	WDX42 -C40-3D-126L	42	225	126	155	70	40	0.60				
68150-48	WDX43 -C40-3D-129L	43	228	129	158	70	40	0.50				
68150-49	WDX44 -C40-3D-132L	44	231	132	161	70	40	0.50				
68150-50	WDX45 -C40-3D-135L	45	234	135	164	70	40	0.40				
68150-51	WDX46 -C40-3D-138L	46	243	138	173	70	40	1.50				
68150-52	WDX47 -C40-3D-141L	47	246	141	176	70	40	1.40				WDX156012
68150-53	WDX48 -C40-3D-144L	48	249	144	179	70	40	1.30				
68150-54	WDX49 -C40-3D-147L	49	252	147	182	70	40	1.20				
68150-55	WDX50 -C40-3D-150L	50	255	150	185	70	40	1.10				
68150-56	WDX51 -C40-3D-153L	51	258	153	188	70	40	1.00				
68150-57	WDX52 -C40-3D-156L	52	261	156	191	70	40	0.90				
68150-58	WDX53 -C40-3D-159L	53	264	159	194	70	40	0.80				
68150-59	WDX54 -C40-3D-162L	54	267	162	197	70	40	0.60				
68150-60	WDX55 -C40-3D-165L	55	270	165	200	70	40	0.50				
68150-61	WDX56 -C40-3D-168L	56	276	168	206	70	40	2.00	WDX186012	T25	M6.0-15.0-9.0-60	
68150-62	WDX57 -C40-3D-171L	57	279	171	209	70	40	55				1.80
68150-63	WDX58 -C40-3D-174L	58	282	174	212	70	40	56				1.70
68150-64	WDX59 -C40-3D-177L	59	285	177	215	70	40	57				1.60
68150-65	WDX60 -C40-3D-180L	60	288	180	218	70	40	58				1.50
68150-66	WDX61 -C40-3D-183L	61	291	183	221	70	40	59				1.40
68150-67	WDX62 -C40-3D-186L	62	294	186	224	70	40	60				1.30
68150-68	WDX63 -C40-3D-189L	63	297	189	227	70	40	61				1.20
68150-69	WDX64 -C40-3D-192L	64	300	192	230	70	40	62				1.00
68150-70	WDX65 -C40-3D-195L	65	303	195	233	70	40	63				0.90
68150-71	WDX66 -C40-3D-198L	66	306	198	236	70	40	64	0.70			
68150-72	WDX67 -C40-3D-201L	67	309	201	239	70	40	65	0.60			
68150-73	WDX68 -C40-3D-204L	68	312	204	242	70	40	65	0.50			
68150-74	WDX14.5-C25-3D-43.5L	14.5	122	43.5	66	56	25	32	0.20	WDX042004	T6	M1.8-3.0-2.4-60
68150-75	WDX24.5-C32-3D-73.5L	24.5	156	73.5	96	60	32	38.5	0.50	WDX073506	T8	M2.5-6.0-3.5-60



Cutting Tool

68160 WDX-4D Rapid Drill (4D)

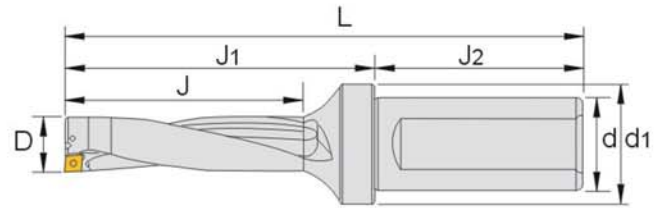

90° Unit:mm

Order No.	Model	D	L	J	J1	J2	d	d1	Deviation	Inserts	Wrench	Screw
68160-01	WDX13 -C25-4D-52L	13	132	52	76	56	25	32	0.35	WDXT042004	T6	M1.6-2.7-2.4-60
68160-02	WDX13.5-C25-4D-56L	13.5	132	54	76	56	25		0.30			
68160-03	WDX14 -C25-4D-56L	14	136	56	80	56	25		0.25			
68160-04	WDX14.5-C25-4D-60L	14.5	136	58	80	56	25		0.20			
68160-05	WDX15 -C25-4D-60L	15	140	60	84	56	25		0.15			
68160-06	WDX15.5-C25-4D-64L	15.5	140	62	84	56	25		0.40			
68160-07	WDX16 -C25-4D-64L	16	144	64	88	56	25		0.40			
68160-08	WDX16.5-C25-4D-68L	16.5	144	66	88	56	25		0.35			
68160-09	WDX17 -C25-4D-68L	17	148	68	92	56	25		0.30			
68160-10	WDX17.5-C25-4D-72L	17.5	148	70	92	56	25		0.25			
68160-11	WDX18 -C25-4D-72L	18	152	72	96	56	25	0.20				
68160-12	WDX18.5-C25-4D-76L	18.5	152	74	96	56	25	0.50	WDXT063006	T7	M2.2-5.5-3.4-60	
68160-13	WDX19 -C25-4D-76L	19	156	76	100	56	25	0.45				
68160-14	WDX19.5-C25-4D-80L	19.5	156	78	100	56	25	0.40				
68160-15	WDX20 -C25-4D-80L	20	160	80	104	56	25	0.30				
68160-16	WDX20.5-C25-4D-84L	20.5	160	82	104	56	25	0.30				
68160-17	WDX21 -C25-4D-84L	21	164	84	108	56	25	0.20				
68160-18	WDX21.5-C25-4D-88L	21.5	164	86	108	56	25	0.15				
68160-19	WDX22 -C25-4D-88L	22	168	88	112	56	25	0.10				
68160-20	WDX22.5-C25-4D-92L	22.5	168	90	112	56	25	0.05				
68160-21	WDX23 -C25-4D-92L	23	172	92	116	56	25	0.70				
68160-22	WDX23.5-C32-4D-96L	23.5	176	94	116	60	32	38.5	0.70	WDXT073506	T8	M2.5-6.0-3.5-60
68160-23	WDX24 -C32-4D-96L	24	180	96	120	60	32		0.60			
68160-24	WDX24.5-C32-4D-100L	24.5	180	98	120	60	32		0.50			
68160-25	WDX25 -C32-4D-100L	25	184	100	124	60	32		0.50			
68160-26	WDX25.5-C32-4D-104L	25.5	184	102	124	60	32		0.45			
68160-27	WDX26 -C32-4D-104L	26	193	104	133	60	32		0.40			
68160-28	WDX26.5-C32-4D-108L	26.5	193	106	133	60	32		0.35			
68160-29	WDX27 -C32-4D-108L	27	197	108	137	60	32		0.25			
68160-30	WDX27.5-C32-4D-112L	27.5	197	110	137	60	32		0.20			
68160-31	WDX28 -C32-4D-112L	28	201	112	141	60	32		0.15			
68160-32	WDX28.5-C32-4D-116L	28.5	201	114	141	60	32		0.10			

CUTTING TOOL

Unit:mm

Order No.	Model	D	L	J	J ₁	J ₂	d	d ₁	Deviation	Inserts	Wrench	Screw
68160-33	WDX29 -C32-4D-116L	29	205	116	145	60	32	38.5	1.00	WDXT094008	T15	M3.5-8.0-5.3-60
68160-34	WDX29.5-C32-4D-120L	29.5	205	118	149	60	32		0.95			
68160-35	WDX30 -C32-4D-120L	30	209	120	149	60	32		0.90			
68160-36	WDX31 -C32-4D-124L	31	213	124	153	60	32		0.80			
68160-37	WDX32 -C32-4D-128L	32	217	128	157	60	32		0.70			
68160-38	WDX33 -C32-4D-132L	33	221	132	161	60	32		0.55			
68160-39	WDX34 -C32-4D-136L	34	225	136	165	60	32		0.45			
68160-40	WDX35 -C32-4D-140L	35	229	140	169	60	32		0.35			
68160-41	WDX36 -C32-4D-144L	36	233	144	173	60	32		0.20			
68160-42	WDX37 -C32-4D-148L	37	237	148	177	60	32		1.00			
68160-43	WDX38 -C32-4D-152L	38	241	152	181	60	32	1.00	WDXT125012	T20	M5.0-11.0-7.0-60	
68160-44	WDX39 -C32-4D-156L	39	245	156	185	60	32	0.90				
68160-45	WDX40 -C40-4D-160L	40	259	160	189	70	40	0.80				
68160-46	WDX41 -C40-4D-164L	41	263	164	193	70	40	0.70				
68160-47	WDX42 -C40-4D-168L	42	267	168	197	70	40	0.60				
68160-48	WDX43 -C40-4D-172L	43	271	172	201	70	40	0.50				
68160-49	WDX44 -C40-4D-176L	44	275	176	205	70	40	0.50				
68160-50	WDX45 -C40-4D-180L	45	279	180	209	70	40	0.40				
68160-51	WDX46 -C40-4D-184L	46	289	184	219	70	40	1.50				
68160-52	WDX47 -C40-4D-188L	47	293	188	223	70	40	1.40				
68160-53	WDX48 -C40-4D-192L	48	297	192	227	70	40	1.30	WDXT156012	T25	M6.0-15.0-9.0-60	
68160-54	WDX49 -C40-4D-196L	49	301	196	231	70	40	1.20				
68160-55	WDX50 -C40-4D-200L	50	305	200	235	70	40	1.10				
68160-56	WDX51 -C40-4D-204L	51	309	204	239	70	40	1.00				
68160-57	WDX52 -C40-4D-208L	52	313	208	243	70	40	0.90				
68160-58	WDX53 -C40-4D-212L	53	317	212	247	70	40	0.80				
68160-59	WDX54 -C40-4D-216L	54	321	216	251	70	40	0.60				
68160-60	WDX55 -C40-4D-220L	55	325	220	255	70	40	0.50				
68160-61	WDX56 -C40-4D-224L	56	332	224	262	70	40	2.00				
68160-62	WDX57 -C40-4D-228L	57	336	228	266	70	40	55				1.80
68160-63	WDX58 -C40-4D-232L	58	340	232	270	70	40	56	1.70			
68160-64	WDX59 -C40-4D-236L	59	344	236	274	70	40	57	1.60			
68160-65	WDX60 -C40-4D-240L	60	348	240	278	70	40	58	1.50			
68160-66	WDX61 -C40-4D-244L	61	352	244	282	70	40	59	1.40			
68160-67	WDX62 -C40-4D-248L	62	356	248	288	70	40	60	1.30			
68160-68	WDX63 -C40-4D-252L	63	360	252	290	70	40	61	1.20			
68160-69	WDX64 -C40-4D-256L	64	364	256	294	70	40	62	1.00			
68160-70	WDX65 -C40-4D-260L	65	368	260	298	70	40	63	0.90			
68160-71	WDX66 -C40-4D-264L	66	372	264	302	70	40	64	0.70			
68160-72	WDX67 -C40-4D-268L	67	376	268	306	70	40	65	0.60			
68160-73	WDX68 -C40-4D-272L	68	380	272	310	70	40	66	0.50			



CUTTING TOOL

Cutting Tool

68170

WDX-5D

Rapid Drill (5D)

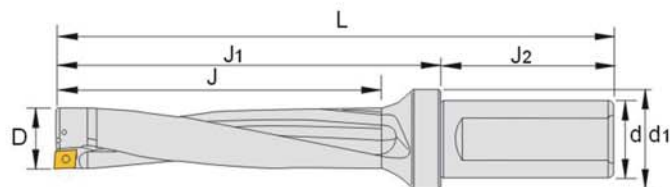

90° Unit:mm

Order No.	Model	D	L	J	J1	J2	d	d1	Deviation	Inserts	Wrench	Screw
68170-01	WDX17 -C25-5D-85L	17	159	85	109	56	25	32	0.30	WDX052504	T6	M2.0-5.0-2.7-60
68170-02	WDX17.5-C25-5D-90L	17.5	159	87.5	109	56	25		0.25			
68170-03	WDX18 -C25-5D-90L	18	164	90	114	56	25		0.20			
68170-04	WDX18.5-C25-5D-95L	18.5	170	92.5	114	56	25		0.50			
68170-05	WDX19 -C25-5D-95L	19	175	95	119	56	25		0.45			
68170-06	WDX19.5-C25-5D-100L	19.5	175	97.5	119	56	25		0.40			
68170-07	WDX20 -C25-5D-100L	20	180	100	124	56	25		0.30	WDX063006	T7	M2.2-5.5-3.4-60
68170-08	WDX20.5-C25-5D-105L	20.5	180	102.5	124	56	25		0.30			
68170-09	WDX21 -C25-5D-105L	21	185	105	129	56	25		0.20			
68170-10	WDX21.5-C25-5D-110L	21.5	185	107.5	129	56	25		0.15			
68170-11	WDX22 -C25-5D-110L	22	190	110	134	56	25		0.10			
68170-12	WDX22.5-C25-5D-115L	22.5	190	112.5	134	56	25		0.05			
68170-13	WDX23 -C25-5D-115L	23	195	115	139	56	25	0.70	WDX073506	T8	M2.5-6.0-3.5-60	
68170-14	WDX23.5-C32-5D-120L	23.5	195	117.5	135	60	32	0.70				
68170-15	WDX24 -C32-5D-120L	24	204	120	144	60	32	0.60				
68170-16	WDX24.5-C32-5D-125L	24.5	204	122.5	144	60	32	0.50				
68170-17	WDX25 -C32-5D-125L	25	209	125	149	60	32	0.50				
68170-18	WDX25.5-C32-5D-130L	25.5	209	127.5	149	60	32	0.45				
68170-19	WDX26 -C32-5D-130L	26	219	130	159	60	32	0.40				
68170-20	WDX26.5-C32-5D-135L	26.5	219	132.5	159	60	32	0.35				
68170-21	WDX27 -C32-5D-135L	27	224	135	164	60	32	0.25				
68170-22	WDX27.5-C32-5D-140L	27.5	224	137.5	164	60	32	0.20				
68170-23	WDX28 -C32-5D-140L	28	229	140	169	60	32	0.15				
68170-24	WDX28.5-C32-5D-145L	28.5	229	142.5	169	60	32	0.10				38.5
68170-25	WDX29 -C32-5D-145L	29	234	145	174	60	32	1.00				
68170-26	WDX29.5-C32-5D-150L	29.5	234	147.5	174	60	32	0.95				
68170-27	WDX30 -C32-5D-150L	30	239	150	179	60	32	0.90				
68170-28	WDX31 -C32-5D-155L	31	244	155	184	60	32	0.80				
68170-29	WDX32 -C32-5D-160L	32	249	160	189	60	32	0.70				
68170-30	WDX33 -C32-5D-165L	33	254	165	194	60	32	0.55				
68170-31	WDX34 -C32-5D-170L	34	259	170	199	60	32	0.45				
68170-32	WDX35 -C32-5D-175L	35	264	175	204	60	32	0.35				
68170-33	WDX36 -C32-5D-180L	36	269	180	209	60	32	0.20				

CUTTING TOOL

Unit:mm

Order No.	Model	D	L	J	J1	J2	d	d1	Deviation	Inserts	Wrench	Screw			
68170-34	WDX37 -C32-5D-185L	37	274	185	214	60	32	38.5	1.00	WDXT125012	T20	M5-11-7.0-60			
68170-35	WDX38 -C32-5D-190L	38	279	190	219	60	32		1.00						
68170-36	WDX39 -C32-5D-195L	39	284	195	224	60	32		0.90						
68170-37	WDX40 -C40-5D-200L	40	299	200	229	70	40	48	0.80						
68170-38	WDX41 -C40-5D-205L	41	304	205	234	70	40		0.70						
68170-39	WDX42 -C40-5D-210L	42	309	210	239	70	40		0.60						
68170-40	WDX43 -C40-5D-215L	43	314	215	244	70	40		0.50						
68170-41	WDX44 -C40-5D-220L	44	319	220	249	70	40		0.50						
68170-42	WDX45 -C40-5D-225L	45	324	225	254	70	40		0.40						
68170-43	WDX46 -C40-5D-230L	46	335	230	265	70	40		1.50						
68170-44	WDX47 -C40-5D-235L	47	340	235	270	70	40		1.40						
68170-45	WDX48 -C40-5D-240L	48	345	240	275	70	40		1.30						
68170-46	WDX49 -C40-5D-245L	49	350	245	280	70	40		1.20						
68170-47	WDX50 -C40-5D-250L	50	355	250	285	70	40	54	1.10				WDXT156012	T25	M6-15-9.0-60
68170-48	WDX51 -C40-5D-255L	51	360	255	290	70	40		1.00						
68170-49	WDX52 -C40-5D-260L	52	365	260	295	70	40		0.90						
68170-50	WDX53 -C40-5D-265L	53	370	265	300	70	40		0.80						
68170-51	WDX54 -C40-5D-270L	54	375	270	305	70	40		0.60						
68170-52	WDX55 -C40-5D-275L	55	380	275	310	70	40		0.50						



Cutting Tool

WDX FAST DRILL CUTTING DATA

Workpieces	HB	HR.C	Recommend	(Vc)m/min	(f)mm/rev				
					φ13.0~φ18.0	φ18.5~φ29.0	φ29.5~φ36.0	φ37.0~φ55.0	
P	SS400	125	(14)	G ACP300	100-150-200	0.05-0.07-0.10	0.05-0.07-0.10	0.05-0.08-0.11	0.05-0.08-0.12
	S15C	125	24	L ACP300	130-170-220	0.04-0.07-0.10	0.04-0.07-0.10	0.04-0.08-0.11	0.05-0.09-0.12
	S45C	190	27	G ACP300	100-150-200	0.08-0.12-0.20	0.08-0.12-0.20	0.08-0.13-0.22	0.09-0.14-0.24
	S45C Temper	250	31	G ACP300	80-120-160	0.06-0.10-0.15	0.06-0.10-0.15	0.06-0.11-0.16	0.07-0.12-0.18
	S75C	270		G ACP300	100-130-160	0.08-0.12-0.18	0.08-0.12-0.18	0.08-0.13-0.19	0.09-0.14-0.22
	S75C Temper	300		G ACP300	70-100-140	0.06-0.10-0.14	0.06-0.10-0.14	0.06-0.11-0.15	0.07-0.12-0.17
	SCM,SNCM	180		L ACP300	100-140-180	0.05-0.07-0.12	0.05-0.07-0.12	0.05-0.08-0.13	0.06-0.08-0.15
	SCM,SNCM Temper	275	28	G ACP300	80-120-160	0.06-0.10-0.14	0.06-0.10-0.14	0.06-0.11-0.15	0.07-0.12-0.17
	SCM,SNCM Temper	300	31	G ACP300	75-110-140	0.06-0.10-0.14	0.06-0.10-0.14	0.06-0.11-0.15	0.07-0.12-0.17
	SCM,SNCM Temper	350	37	G ACP300	60-85-110	0.06-0.10-0.14	0.06-0.10-0.14	0.06-0.11-0.15	0.07-0.12-0.17
	SKD,SKT,SKH	200	(14)	G ACP300	100-130-160	0.08-0.12-0.20	0.08-0.12-0.20	0.08-0.13-0.22	0.09-0.14-0.24
	SKD,SKT,SKH Temper	325	34	G ACP300	80-100-120	0.06-0.10-0.15	0.06-0.10-0.15	0.06-0.11-0.16	0.07-0.12-0.18
M	SUS403	200	(14)	G ACP300	100-140-180	0.06-0.10-0.15	0.06-0.10-0.15	0.06-0.11-0.16	0.07-0.12-0.18
	SUS403	240	22	G ACP300	90-120-150	0.06-0.10-0.15	0.06-0.10-0.15	0.06-0.11-0.16	0.07-0.12-0.18
	SUS304,SUS316	180		G ACP300	100-140-180	0.06-0.10-0.15	0.06-0.10-0.15	0.06-0.11-0.16	0.07-0.12-0.18
K	Casting Iron Ductile Iron			H ACK300	120-160-200	0.09-0.18-0.27	0.10-0.20-0.30	0.11-0.22-0.32	0.12-0.24-0.36
				H ACK300	90-120-150	0.09-0.18-0.27	0.10-0.20-0.30	0.11-0.22-0.32	0.12-0.24-0.36
S	Difficult to cut materials, heat resistant alloy, super alloy, Ti alloy etc.	200	(14)	G ACP300	25-50-70	0.06-0.10-0.15	0.06-0.10-0.15	0.06-0.11-0.16	0.07-0.12-0.18
N	Aluminum Copper alloy			G DL1500	200-260-320	0.06-0.11-0.17	0.06-0.11-0.17	0.06-0.12-0.18	0.07-0.13-0.20
				G DI1500	180-230-280	0.06-0.11-0.17	0.06-0.11-0.17	0.06-0.12-0.18	0.07-0.13-0.20

1. Spindle rpm (S) = (1000xVc) / (π x O.D.)

2. Work table feeding (F) = S x Flutes(T) x f

3. The table is referring to 3x O.D., actual cutting statics varies depending on machine conditions.

4. Decrease 15% feed for over 4x rapid drill.

5. Decrease 10% feed for non coolant through design.

68180

HWAS

Eccentric Sleeve

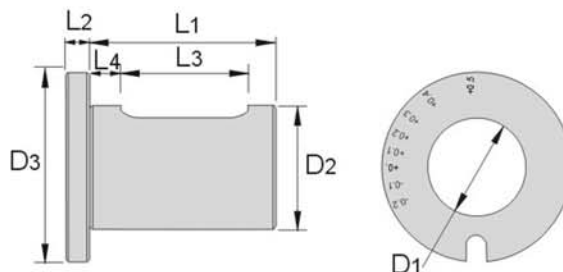

Order No.	Model	D1	D2	D3	L1	L2	L3	L4	Wrench
68180-01	HWAS2532	25	32	42	60	7	46	6	+0.5~-0.2
68180-02	HWAS3240	32	40	55	70	7	57	6	+0.5~-0.3

1. Graduation reading is only for reference, actual statics will depending on practical processing.

2. Apply side fix shank, normal collet or spring collet chuck are not suitable.

3. The adjustable range means dia. adjustment range.

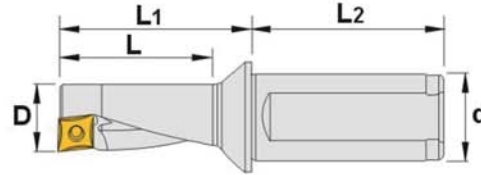

HCAP Turning Fast Drill-2.25D

Unit:mm

Order No.	Model	D	d	L	L1	L2	Inserts	Wrench
68190-01	HCAP-08R-C12-2.25D-18L	8	12	18	24	42	XCM(N)T 0401	T6
68190-02	HCAP-10R-C12-2.25D-22.5L	10	12	22.5	29	42	XCM(N)T 0502	T6
68190-03	HCAP-12R-C16-2.25D-27L	12	16	27	35	45	XCM(N)T 0602	T7
68190-04	HCAP-14R-C16-2.25D-31.5L	14	16	31.5	40	45	XCM(N)T 0703	T8
68190-05	HCAP-16R-C20-2.25D-36L	16	20	36	45	50	XCM(N)T 0803	T9
68190-06	HCAP-20R-C25-2.25D-45L	20	25	45	56	56	XCM(N)T 10T3	T15

HCAP Turning Fast Drill-3D

Unit:mm

Order No.	Model	D	d	L	L1+L2	Inserts	Wrench	
68200-01	HCAP-08R-C12-3D-24L	8	12	24	30	42	XCM(N)T 0401	T6
68200-02	HCAP-10R-C12-3D-30L	10	12	30	36.5	42	XCM(N)T 0502	T6
68200-03	HCAP-12R-C16-3D-36L	12	16	36	44	45	XCM(N)T 0602	T7
68200-04	HCAP-14R-C16-3D-42L	14	16	42	50.5	45	XCM(N)T 0703	T8
68200-05	HCAP-16R-C20-3D-48L	16	20	48	57	50	XCM(N)T 0803	T9
68200-06	HCAP-20R-C25-3D-60L	20	25	60	51	56	XCM(N)T 10T3	T15

1. Single Drill, capable of inner and outer dia. drilling, reduce inserts replacement and more efficiency.
2. twist type for better chips removal

HCAP Cutting Statics

Unit:mm

	Workpieces	Hardness	Drill rpm	Cutting rpm
P	Low carbon steel	~150	130~240	150~270
	Carbon steel	150~250	90~160	100~180
	Low alloy steel	~180	120~210	140~230
	Medium alloy steel	200~250	70~140	80~160
	High alloy steel	250~350	50~100	60~120
M	Stainless steel(martensite)	200	110~180	130~200
	Stainless steel(austenitic)	200	90~160	100~180
K	Gray cast iron	180~220	110~180	120~200
	Nodular cast iron	200~240	90~160	100~180
N	Aluminum alloy	60~130	100~500	150~600
	Copper alloy	90~100	100~400	100~500

Inserts	Processing method	Flute Depth	Flute Feed
XCMT040104	Lathe cutting	0.6(0.2~1.8)	0.05(0.02~0.15)
	drill hole	-	0.06(0.02~0.09)
XCMT050204	Lathe cutting	0.8(0.2~2.2)	0.08(0.03~0.18)
	drill hole	-	0.06(0.02~0.11)
XCMT060204	Lathe cutting	1.0(0.3~2.5)	0.08(0.03~0.20)
	drill hole	-	0.08(0.03~0.12)
XCMT070304	Lathe cutting	1.2(0.4~2.8)	0.12(0.05~0.22)
	drill hole	-	0.08(0.03~0.13)
XCMT080304	Lathe cutting	1.5(0.4~3.2)	0.12(0.06~0.25)
	drill hole	-	0.08(0.03~0.13)
XCMT10T304	Lathe cutting	1.8(0.5~3.5)	0.12(0.06~0.30)
	drill hole	-	0.08(0.03~0.13)



Cutting Tool

68210

HD-3D

Rapid Drill (3D)

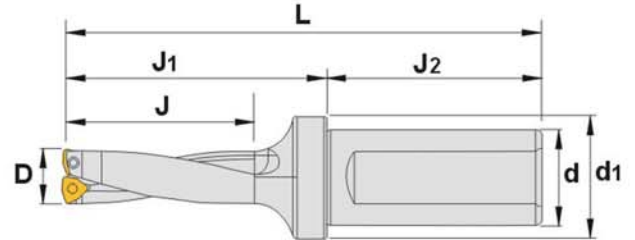

Unit:mm

Order No.	Model	D	L	J	J1	J2	d	d1	Inserts	Wrench	Screw				
68210-01	HD15-C25-3D-45L	15	118	45	62	56	25	32	WC□□0302	T8	M2.5-6.0-3.5-60				
68210-02	HD16-C25-3D-48L	16	121	48	65	56	25								
68210-03	HD17-C25-3D-51L	17	124	51	68	56	25								
68210-04	HD18-C25-3D-54L	18	127	54	71	56	25								
68210-05	HD19-C25-3D-57L	19	130	57	74	56	25								
68210-06	HD20-C25-3D-60L	20	133	60	77	56	25								
68210-07	HD21-C25-3D-63L	21	136	63	80	56	25								
68210-08	HD22-C25-3D-66L	22	139	66	83	56	25								
68210-09	HD23-C25-3D-69L	23	142	69	86	56	25								
68210-10	HD24-C32-3D-72L	24	146	72	86	60	32								
68210-11	HD25-C32-3D-75L	25	150	75	90	60	32	38.5	WC□□0402	T8	M2.5-6.0-3.5-60				
68210-12	HD26-C32-3D-78L	26	154	78	94	60	32								
68210-13	HD27-C32-3D-81L	27	158	81	98	60	32								
68210-14	HD28-C32-3D-84L	28	162	84	102	60	32								
68210-15	HD29-C32-3D-87L	29	166	87	106	60	32								
68210-16	HD30-C32-3D-90L	30	170	90	110	60	32								
68210-17	HD31-C32-3D-93L	31	174	93	114	60	32								
68210-18	HD32-C32-3D-96L	32	178	96	118	60	32								
68210-19	HD33-C32-3D-99L	33	182	99	122	60	32								
68210-20	HD34-C32-3D-102L	34	186	102	126	60	32								
68210-21	HD35-C32-3D-105L	35	190	105	130	60	32	48.5	WC□□0503	T9	M3-8.0-4.4-60				
68210-22	HD36-C32-3D-108L	36	194	108	134	60	32								
68210-23	HD37-C32-3D-111L	37	198	111	138	60	32								
68210-24	HD38-C32-3D-114L	38	202	114	142	60	32								
68210-25	HD39-C32-3D-117L	39	206	117	146	60	32								
68210-26	HD40-C40-3D-120L	40	216	120	146	70	40								
68210-27	HD41-C40-3D-123L	41	220	123	150	70	40								
													WC□□06T3	T15	M3.5-8.0-5.3-60

CUTTING TOOL

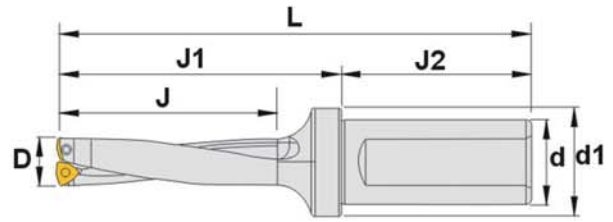
68220
HD-4D
Rapid Drill (4D)

Unit:mm

Order No.	Model	D	L	J	J1	J2	d	d1	Inserts	Wrench	Screw
68220-01	HD15-C25-4D-60L	15	140	60	83	56	25	32	WC□□0302	T8	M2.5-6.0-3.5-60
68220-02	HD16-C25-4D-64L	16	144	64	87	56	25				
68220-03	HD17-C25-4D-68L	17	148	68	91	56	25				
68220-04	HD18-C25-4D-72L	18	152	72	95	56	25				
68220-05	HD19-C25-4D-76L	19	156	76	99	56	25				
68220-06	HD20-C25-4D-80L	20	160	80	103	56	25				
68220-07	HD21-C25-4D-84L	21	164	84	107	56	25				
68220-08	HD22-C25-4D-88L	22	168	88	111	56	25				
68220-09	HD23-C25-4D-92L	23	172	92	115	56	25				
68220-10	HD24-C32-4D-96L	24	185	96	119	60	32	WC□□0503	T9	M3.5-8.0-4.4-60	
68220-11	HD25-C32-4D-100L	25	189	100	123	60	32				
68220-12	HD26-C32-4D-104L	26	193	104	127	60	32				
68220-13	HD27-C32-4D-108L	27	197	108	131	60	32				
68220-14	HD28-C32-4D-112L	28	201	112	135	60	32				
68220-15	HD29-C32-4D-116L	29	205	116	139	60	32				
68220-16	HD30-C32-4D-120L	30	209	120	143	60	32				
68220-17	HD31-C32-4D-124L	31	213	124	147	60	32				
68220-18	HD32-C32-4D-128L	32	217	128	151	60	32				
68220-19	HD33-C32-4D-132L	33	221	132	155	60	32	WC□□06T3	T15	M3.5-8.0-5.3-60	
68220-20	HD34-C32-4D-136L	34	225	136	159	60	32				
68220-21	HD35-C32-4D-140L	35	229	140	163	60	32				
68220-22	HD36-C32-4D-144L	36	233	144	167	60	32				
68220-23	HD37-C32-4D-148L	37	237	148	171	60	32				
68220-24	HD38-C32-4D-152L	38	241	152	175	60	32				
68220-25	HD39-C32-4D-156L	39	245	156	185	60	32				
68220-26	HD40-C40-4D-160L	40	260	160	190	70	40				
68220-27	HD41-C40-4D-164L	41	264	164	194	70	40				



CUTTING TOOL

Cutting Tool

68230

SRB

High Speed Rough Boring Cutter

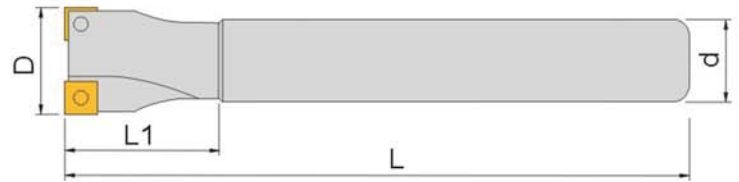

Cutting Example:

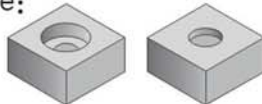

Unit:mm

Order No.	Model	D	d	L1	L	T	Inserts	Wrench	Screw
68230-1210	SRB 1210R-2T	11.8	10	20	100	2	SPMG 050204	TS2003	TK06
68230-1312	SRB 1312R-2T	12.8	12	20	100				
68230-1412	SRB 1412R-2T	13.8	12	25	100				
68230-1512	SRB 1512R-2T	14.8	12	25	100				
68230-1612	SRB 1612R-2T	15.8	12	30	100		SPMG 060204	TS2205	TK06
68230-1816	SRB 1816R-2T	17.7	16	30	130				
68230-2016	SRB 2016R-2T	19.7	16	30	130				
68230-2216	SRB 2216R-2T	21.7	16	30	130				
68230-2420	SRB 2420R-2T	23.7	20	30	150		SPMG 090408	TS3504	TK15
68230-2520	SRB 2520R-2T	24.7	20	30	150				
68230-2620	SRB 2620R-2T	25.7	20	30	150				
68230-2720	SRB 2720R-2T	26.7	20	30	150				
68230-2820	SRB 2820R-2T	27.7	20	30	150		SPMG 110408	TS4006	TK15
68230-3025	SRB 3025R-2T	29.7	25	40	200				
68230-3225	SRB 3225R-2T	31.7	25	40	200				
68230-3525	SRB 3525R-2T	34.7	25	40	200				
68230-3625	SRB 3625R-2T	35.7	25	40	200		SPMG 110408	TS4006	TK15
68230-4025	SRB 4025R-2T	39.7	25	40	200				
68230-4232	SRB 4232R-2T	41.7	32	45	200				
68230-4532	SRB 4532R-2T	44.7	32	45	200				
68230-4832	SRB 4832R-2T	47.7	32	45	200	SPMG 110408	TS4006	TK15	
68230-5032	SRB 5032R-2T	49.7	32	45	200				

CUTTING TOOL

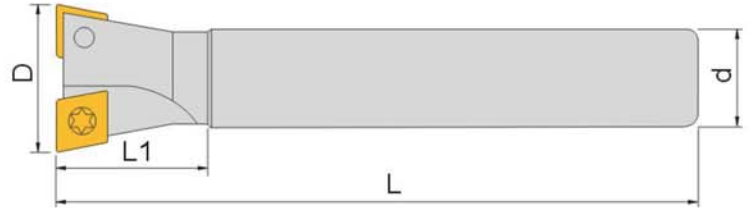
68240
FRB
Rough Boring Cutter

Cutting Example:

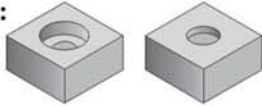

Unit:mm

Order No.	Model	D	d	L1	L	Inserts	Wrench	Screw
68240-1412	FRB 1412R-1T	13.8	12	25	100	CCMT 060204	TS2515	TK08
68240-1612	FRB 1612R-2T	15.8	12	30	100			
68240-1816	FRB 1816R-2T	17.7	16	30	120			
68240-1916	FRB 1916R-2T	18.7	16	30	120			
68240-2016	FRB 2016R-2T	19.7	16	30	120			
68240-2216	FRB 2216R-2T	21.7	16	30	120			
68240-2420	FRB 2420R-2T	23.7	20	30	130			
68240-2520	FRB 2520R-2T	24.7	20	30	130			
68240-2620	FRB 2620R-2T	25.7	20	30	130	CCMT 09T304	TS4004	TK15
68240-2720	FRB 2720R-2T	26.7	20	30	130			
68240-2820	FRB 2820R-2T	27.7	20	30	130			
68240-3025	FRB 3025R-2T	29.7	25	40	160			
68240-3225	FRB 3225R-2T	31.7	25	40	160			
68240-3525	FRB 3525R-2T	34.7	25	40	160			
68240-3625	FRB 3625R-2T	35.7	25	40	160			
68240-4025	FRB 4025R-2T	39.7	25	40	160			
68240-4232	FRB 4232R-2T	41.7	32	45	200			
68240-4532	FRB 4532R-2T	44.7	32	45	200			
68240-4832	FRB 4832R-2T	47.7	32	45	200			
68240-5032	FRB 5032R-2T	49.7	32	45	200			
68240-5232	FRB 5232R-2T	51.7	32	45	200			
68240-5532	FRB 5532R-2T	54.7	32	45	200			



CUTTING TOOL

Cutting Tool

68250

HSP

Chamfering End Mill



45°

HSP 45° Chamfering End Mill

Unit:mm

Order No.	Model	D	L	L1	d	a	Chamfering range	Inserts	Wrench	Screw
68250-01	HSP45-1212-105	12	105	26	12	8	∅0~∅6	TC□□1003	T8	M2.5-6.0-3.5-60
68250-02	HSP45-2012-100	20	100	22	12	11.3	∅0~∅20	TC□□16T3	T15	M4.0-10-5.0-43
68250-03	HSP45-2020-120	20	120	50	20	11.3	∅0~∅20			

60°

HSP 60° Chamfering End Mill

Unit:mm

Order No.	Model	D	L	L1	d	a	Inserts	Wrench	Screw
68260-01	HSP60-1212-105L	13.8	105	26	12	8.5	TC□□1003	T8	M2.5-6.0-3.5-60
68260-02	HSP60-1616-110L	19.2	110	30	16	11.16	TC□□13T3	T15	M3.5-8.0-5.0-43
68260-03	HSP60-2020-130L	22.5	130	50	20	11.83	TC□□16T3		M4.0-10-5.0-43

30°

HSP 30° Chamfering End Mill

Unit:mm

Order No.	Model	D	L	L1	d	a	Inserts	Wrench	Screw
68270-01	HSP30-1212-105L	13.8	105	26	12	8.5	TC□□1003	T8	M2.5-6.0-3.5-60
68270-02	HSP30-1616-110L	19.2	110	30	16	11.16	TC□□13T3	T15	M3.5-8.0-5.0-43
68270-03	HSP30-2020-130L	22.5	130	50	20	11.83	TC□□16T3		M4.0-10-5.0-43

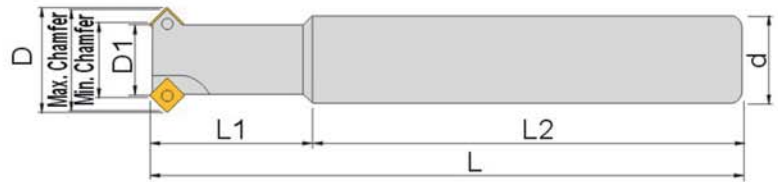
68280
HSC45°
45° Inner/Outer Chamfering End Mills

45°

Unit:mm

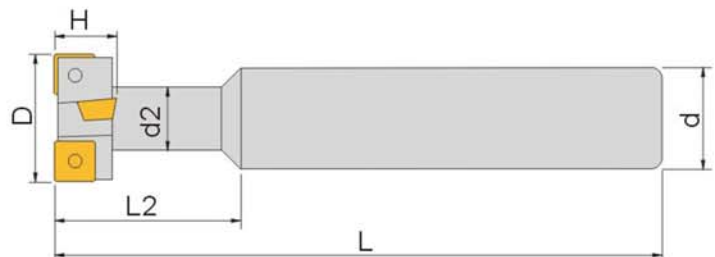
Order No.	Model	D	Max. Chamfer	Min. Chamfer	Min.Dia.	d	L	L1	L2	Inserts	Wrench	Screw
68280-01	HSC-1510-C12-2T	15.7	15	10	8.9	12	120	20	100	SPMG050204	T6	M2.0-5.0-2.7-60
68280-02	HSC-1914-C16-3T	19.7	19	14	12.9	16	150	30	120			
68280-03	HSC-2318-C20-4T	23.7	23	18	16.9	20	150	35	115			
68280-04	HSC-2921-C20-3T	29.9	29	21	19.3	20	150	40	110	SPMG07T308	T8	M2.5-6.0-3.5-60
68280-05	HSC-3628-C25-3T	36.9	36	28	26.3	25	150	40	110			
68280-06	HSC-4335-C25-4T	43.9	43	35	33.3	25	150	40	110			
68280-07	HSC-5042-C25-4T	50.9	50	42	40.3	25	150	40	110			

68290
HST
T-Slot End Mill

Unit:mm

Order No.	Model	D	H	d2	L	L2	d	Inserts	Wrench	Screw
68290-01	HST-1908-100L-4T	19	8	9.5	100	25	16	SPMG050204	T6	M2.0-5.0-2.7-60
68290-02	HST-2109-100L-4T	21	9	11	100	27	16	SPMG060204	T8	M2.2-5.5-3.4-60
68290-03	HST-2511-100L-4T	25	11	12	100	31	20	SPMG07T308	T8	M2.5-6.0-3.5-60
68290-04	HST-3214-120L-4T	32	14	17	120	40	25	SPMG090408	T10	M3.5-8.0-5.3-60
68290-05	HST-4018-125L-4T	40	18	21	125	50	25	SPMG110408	T15	M4.0-10-5.7-60
68290-06	HST-5022-130L-4T	50	22	27	130	61	32	SPMG140512	T20	M5.0-11-7.0-60



CUTTING TOOL

Cutting Tool

68300

TTA

90° Square Shoulder End Mills

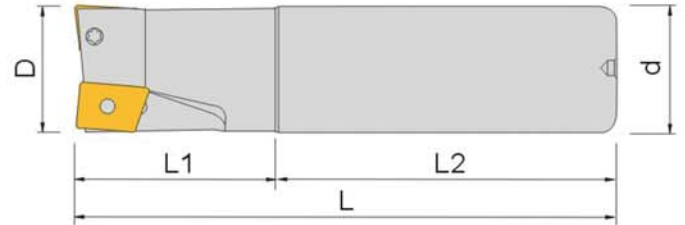

Unit:mm

Order No.	Model	D	d	L	L1	L2	Flutes	Inserts	Wrench	Screw
68300-01	TTA-1010S2-100L	10	10	100	18	82	2	AXMT060204 & AXMT060208	T6	M1.8-3-2.4-60
68300-02	TTA-1010S2-120L	10	10	120	18	102	2			
68300-03	TTA-1110S2-80L	11	10	80	18	62	2			
68300-04	TTA-1110S2-120L	11	10	120	18	102	2			
68300-05	TTA-1212S2-80L	12	12	80	18	62	2			
68300-06	TTA-1212S2-120L	12	12	120	18	102	2			
68300-07	TTA-1212S3-80L	12	12	80	18	62	3			
68300-08	TTA-1212S3-120L	12	12	120	18	102	3			
68300-09	TTA-1312S3-100L	13	12	100	18	82	3			
68300-10	TTA-1312S3-120L	13	12	120	18	102	3			
68300-11	TTA-1412S3-100L	14	12	100	18	82	3			
68300-12	TTA-1412S3-120L	14	12	120	18	102	3			
68300-13	TTA-1516S3-100L	15	16	100	20	80	3			
68300-14	TTA-1516S3-150L	15	16	150	20	130	3			
68300-15	TTA-1616S3-100L	16	16	100	20	80	3			
68300-16	TTA-1616S3-150L	16	16	150	20	130	3			
68300-17	TTA-1716S3-100L	17	16	100	20	80	3			
68300-18	TTA-1716S3-150L	17	16	150	20	130	3			
68300-19	TTA-1816S4-100L	18	16	100	20	80	4			
68300-20	TTA-1816S4-150L	18	16	150	20	130	4			
68300-21	TTA-2020S4-120L	20	20	120	25	95	4			
68300-22	TTA-2020S4-150L	20	20	150	25	125	4			
68300-23	TTA-2120S4-120L	21	20	120	25	95	4			
68300-24	TTA-2120S4-150L	21	20	150	25	125	4			
68300-25	TTA-2220S4-120L	22	20	120	25	95	4			
68300-26	TTA-2220S4-150L	22	20	150	25	125	4			
68300-27	TTA-2525S5-150L	25	25	150	25	125	5			

1. Recommended to use side lock shank.
2. Only use straight shank to hold the drill.
3. TTA End Mill has to be hold at least 1/3 of its own length.
4. If extension is needed, recommended use TTA-SB (68320)

CUTTING TOOL

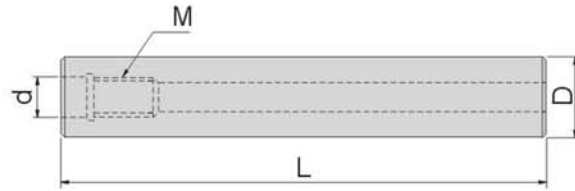
68310
HW
Tungsten Carbide Connection Rod

Unit:mm

Order No.	Model	D	d	L	M
68310-01	HW10-075-M5	10	5.5	75	M5
68310-02	HW10-100-M5	10	5.5	100	M5
68310-03	HW10-150-M5	10	5.5	150	M5
68310-04	HW12-100-M6	12	6.5	100	M6
68310-05	HW12-150-M6	12	6.5	150	M6
68310-06	HW12-200-M6	12	6.5	200	M6
68310-07	HW16-100-M8	16	8.5	100	M8
68310-08	HW16-150-M8	16	8.5	150	M8
68310-09	HW16-200-M8	16	8.5	200	M8
68310-10	HW20-100-M10	20	10.5	100	M10
68310-11	HW20-150-M10	20	10.5	150	M10
68310-12	HW20-200-M10	20	10.5	200	M10
68310-13	HW20-300-M10	20	10.5	300	M10
68310-14	HW25-100-M12	25	12.5	100	M12
68310-15	HW25-150-M12	25	12.5	150	M12
68310-16	HW25-200-M12	25	12.5	200	M12
68310-17	HW25-300-M12	25	12.5	300	M12
68310-18	HW32-150-M16	32	17	150	M16
68310-19	HW32-200-M16	32	17	200	M16
68310-20	HW32-300-M16	32	17	300	M16
68310-21	HW32-400-M16	32	17	400	M16

1. Can be used with thread type End Mills.



CUTTING TOOL

Cutting Tool

68320

TTA-SB

Thread type 90° Square Shoulder End Mills

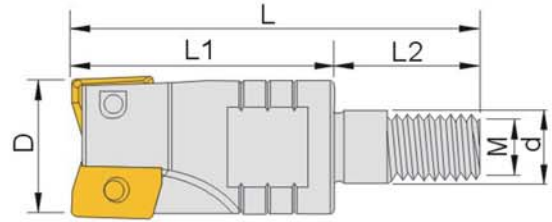

90° Unit:mm

Order No.	Model	D	L	L1	L2	d	M	Flutes	Inserts	Wrench	Screw
68320-01	TTA-SB1102-M5	11	31	20	11	5.5	M5	2	AXMT060204 & AXMT060208	T6	M1.8-3-2.4-60
68320-02	TTA-SB1303-M6	13	34.5	20.5	14	6.5	M6	3			
68320-03	TTA-SB1703-M8	17	42.5	25.5	17	8.5	M8	3			
68320-04	TTA-SB2104-M10	21	48	30	18	10.5	M10	4			

Material:SKD61

TTA Cutting Statics-1

Unit:mm

Workpieces	Hardness	Flute Depth	R.P.M	Recommend	Flute Feed
P Low carbon steel	85-175	1.00~3.00	250~350	TT9030,TT8080	0.04~0.10
	High carbon steel	175-225	150~250	TT9030,TT8080	0.04~0.10
	alloy steel	275-325	120~220	TT9030,TT8080	0.04~0.10
	Tool steel	200-250	90~130	TT8080,TT9030	0.03~0.09
M Stainless steel(martensite)	-	1.00~3.00	120~220	TT8080,TT8020	0.03~0.09
	Stainless steel(austenitic)	-	150~250	TT8080,TT8020	0.03~0.09
S High hardness alloy	-	1.00~2.00	25~40	TT8080,TT8020	0.02~0.07
	Titanium alloy	-	40~50	TT9030,TT8080	0.02~0.07
K Cast iron	190-220	1.00~4.00	250~350	TT9030	0.05~0.10
	Nodular cast iron	140-200	140~280	TT9030	0.05~0.08
N Aluminum	-	1.00~4.00	350~500	K10	0.05~0.15

TTA Cutting Statics-2

Unit:mm

End Mill Spec.	Lateral Feed			Helix Cutting		
	Max. Angle	Max. Depth	Min. Length	Min. Helix Dia.	Max. Helix Dia.	Max. Pitch
TTA10	5°	5	57	13		0.7
					20	2.3
TTA12	6°	5	48	17		1.4
					24	3.4
TTA16	4°	5	72	25		1.7
					32	3
TTA25	3°	5	95	33		1.8
					40	2.8

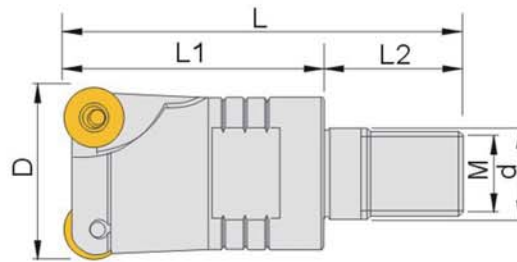
68330
HTR
Thread type End Mill

R } Unit:mm

Order No.	Model	D	L	L1	L2	d	M	Flutes	Inserts	Wrench	Screw
68330-01	HTR-2.5R-12-M6	12	39	17	22	6.5	M6	2	RD□□0501	T6	M2.0-3.8-2.68-43
68330-02	HTR-3.5R-16-M8	16	41	18	23	8.5	M8	2	RD□□0702	T8	M3.5-8.0-5.0-43
68330-03	HTR-3.5R-20-M10	20	49	19	30	10.5	M10	2			
68330-04	HTR-3.5R-25-M12	25	58	23	35	12.5	M12	3			

Material:SKD61

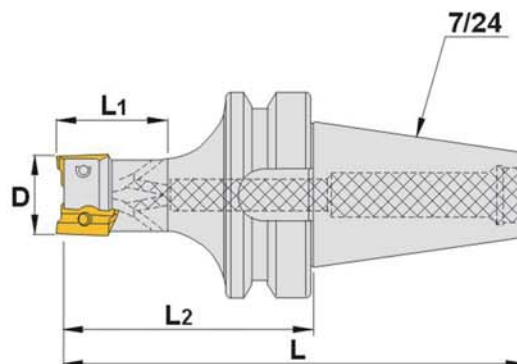
68340
HWEX
Corner Rounding End Mills

Unit:mm

Order No.	Model	D	L1	L2	L	Flutes	Inserts	Wrench	Screw
68340-01	BT40-HWEX16A12-2T-C-90	16	40	90	155	2	AXMT123504	T8	M3.0-6.0-3.8-60
68340-02	BT40-HWEX20A12-3T-C-90	20				3			
68340-03	BT40-HWEX25A12-4T-C-90	25				4			
68340-04	BT40-HWEX25A17-2T-C-90	25				2	AXMT170508	T15	M4.0-9.0-5.6-60
68340-05	BT40-HWEX32A17-3T-C-90	32				3			



CUTTING TOOL

Cutting Tool

68350

HWEX

90° Square Shoulder End Mills

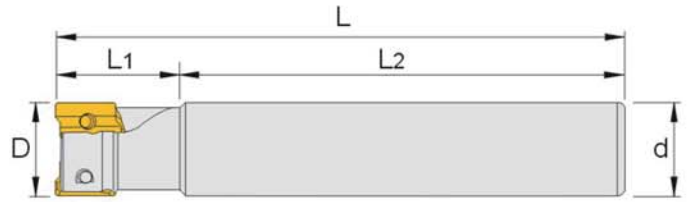

HWEX 90° Square Shoulder End Mills - AXMT1235 Series

90° Unit:mm

Order No.	Model	D	L	L1	L2	d	Flutes	Inserts	Wrench	Screw
68350-01	HWEX12-1616-100L-2T	16	100	25	75	16	2	AX□T1235	T8	M3.0-6.0-3.8-60
68350-02	HWEX12-1716-100L-2T	17	100	25	75	16	2			
68350-03	HWEX12-1816-100L-2T	18	100	25	75	16	2			
68350-04	HWEX12-2020-110L-3T	20	110	30	80	20	3			
68350-05	HWEX12-2220-110L-3T	22	110	30	80	20	3			
68350-06	HWEX12-2525-120L-4T	25	120	35	85	25	4			

HWEX 90° Square Shoulder End Mills - AXMT1705 Series

Unit:mm

Order No.	Model	D	L	L1	L2	d	Flutes	Inserts	Wrench	Screw
68360-01	HWEX17-2525-120L-2T	25	120	35	85	25	2	AX□T1705	T15	M4.0-9.0-5.6-60
68360-02	HWEX17-2625-120L-2T	26	120	35	85	25	2			
68360-03	HWEX17-3025-130L-3T	30	130	40	90	25	3			
68360-04	HWEX17-3232-130L-3T	32	130	40	90	32	3			
68360-05	HWEX17-3532-130L-3T	35	130	40	90	32	3			
68360-06	HWEX17-4032-170L-4T	40	170	50	120	32	4			

CUTTING TOOL

68370
BAP
90° Square Shoulder End Mills

BAP 90° Square Shoulder End Mills - 1135 Series

90° Unit:mm

Order No.	Model	D	d	L	L1	L2	Flutes	Inserts	Wrench	Screw
68370-01	BAP-1212-100L-1T	12	12	100	25	75	1	AP□□1135	T8	M2.5-6.0-3.5-60
68370-02	BAP-1516-150L-2T	15	16	150	25	125	2			
68370-03	BAP-1616-120L-2T	16	16	120	25	95	2			
68370-04	BAP-1616-160L-2T	16	16	160	25	135	2			
68370-05	BAP-1920-150L-2T	19	20	150	30	120	2			
68370-06	BAP-2020-120L-2T	20	20	120	35	85	2			
68370-07	BAP-2020-150L-3T	20	20	150	35	85	3			
68370-08	BAP-2020-150L-2T	20	20	150	35	115	2			
68370-09	BAP-2020-200L-2T	20	20	200	35	165	2			
68370-10	BAP-2525-150L-3T	25	25	150	35	115	3			
68370-11	BAP-2525-150L-3T	25	25	150	35	115	3			

BAP 90° Square Shoulder End Mills - 1604 Series

90° Unit:mm

Order No.	Model	D	d	L	L1	L2	Flutes	Inserts	Wrench	Screw
68380-01	BAP-2525-150L-2T	25	25	150	35	115	2	AP□□1604	T15	M4-10-5.7-60
68380-02	BAP-2525-200L-3T	25	25	200	35	125	3			
68380-03	BAP-2525-300L-3T	25	25	300	35	95	3			
68380-04	BAP-3232-120L-3T	32	32	120	45	135	3			
68380-05	BAP-3232-150L-3T	32	32	150	45	120	3			
68380-06	BAP-3232-200L-3T	32	32	200	45	85	3			
68380-07	BAP-3232-250L-3T	32	32	250	45	85	3			
68380-08	BAP-3232-300L-3T	32	32	300	45	115	3			
68380-09	BAP-3532-200L-3T	35	32	200	45	165	3			
68380-10	BAP-3532-250L-3T	35	32	250	45	115	3			
68380-11	BAP-3532-300L-3T	35	32	300	45	115	3			



CUTTING TOOL

Cutting Tool

68390

HWEXF

90° Square Shoulder Facing End Mills

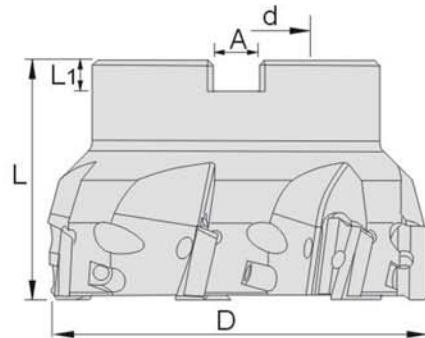

90° Unit:mm

Order No.	Model	D	d	L1	L	A	Flutes	Inserts	Wrench	Screw
68390-01	HWEXF-50-FMB22-5T	50	22	6.3	40	10.4	5	AX□T1705	T15	M4.0-9.0-5.6-60
68390-02	HWEXF-63-FMA25.4-6T	63	25.4	6.3	50	9.5	6			
68390-03	HWEXF-80-FMA25.4-7T	80	25.4	6.3	50	9.5	7			
68390-04	HWEXF-100-FMA31.75-8T	100	31.75	7.5	63	12.7	8			
68390-05	HWEXF-125-FMA38.1-9T	125	38.1	9.5	63	15.9	9			

HWEX Cutting Statics 1

Insert $\varnothing 20$, AXMT1235, Depth 3mm, Width 12.5mm $\varnothing 30$, AXMT1705, Depth 5mm, Width 16mm

Workpieces	Hardness (HB)	Material fz(mm/z)	ACP100			ACP200			ACP300			ACP100			ACP200			ACP300		
			0.08	0.15	0.20	0.08	0.15	0.20	0.08	0.15	0.20	0.12	0.25	0.35	0.12	0.25	0.35	0.12	0.25	0.35
P Low carbon steel	125	Vc (m/min)	380	350	330	350	330	315	330	330	295	400	370	350	370	350	330	350	330	310
	190		285	255	235	255	235	220	235	235	200	300	270	250	270	250	230	250	230	210
	250		235	210	190	210	190	170	190	190	150	250	220	200	220	200	180	200	180	160
	270		190	165	143	171	152	133	152	152	115	200	170	150	180	160	140	160	140	120
	300		145	115	95	115	95	75	95	95	55	150	120	100	120	100	80	100	80	60
	180		265	235	220	235	220	200	220	220	180	280	250	230	250	230	210	230	210	190
	275		170	145	125	150	130	115	130	130	95	180	150	130	160	140	120	140	120	100
	300		150	125	105	135	115	95	115	115	75	160	130	110	140	120	100	120	100	80
	350		125	95	75	105	85	65	85	85	45	130	100	80	110	90	70	90	70	50
	200		235	210	190	210	190	170	190	190	150	250	220	200	220	200	180	200	180	160
	325		125	95	75	95	75	55	75	75	35	130	100	80	100	80	60	80	60	40
M Stainless steel SUS403(martensite)	200	Vc (m/min)	200	170	150	170	150	130	150	150	115	210	180	160	180	160	140	160	140	120
	240		170	140	125	140	125	105	125	125	85	180	150	130	150	130	110	130	110	90
	180		220	190	170	190	190	150	170	170	130	230	200	180	200	180	160	180	160	140

ISO	Workpieces	Hardness (HB)	Material fz(mm/z)	ACK200			ACK300			DL1000			ACK200			ACK300			DL1000		
				0.08	0.15	0.20	0.08	0.15	0.20	0.05	0.15	0.20	0.12	0.25	0.35	0.12	0.25	0.35	0.05	0.15	0.20
S	Cast iron		Vc (m/min)	285	255	235	255	235	220				300	270	250	270	250	230			
	Nodular cast iron			190	160	140	160	140	125				200	170	150	170	150	130			
K	Difficult cutting material	200	Vc (m/min)	45	25		45	25					50	30		50	30				
	Heat resistant alloy, super alloy, titanium alloy	280		45	25		45	25					50	30		50	30				
N	Aluminum alloy Si <13%		Vc (m/min)							1000	750	500							1000	750	500
	Aluminum alloy Si >13%									250	200	170							250	200	170
	Copper alloy									350	330	300							350	330	300

CUTTING TOOL

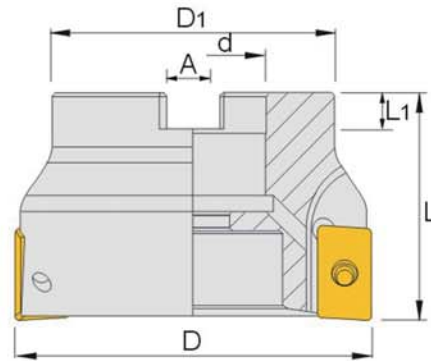

90° Unit:mm

Order No.	Model	D	D1	d	L	L1	A	Flutes	Inserts	Wrench	Screw
68400-01	HFM90-50-25.4-5T	50	48	25.4	40	6.3	10.4	5	AP□□1604	T15	M4-10-5.7-60
68400-02	HFM90-63-25.4-5T	63	48	25.4	40	6.3	10.4	5			
68400-03	HFM90-80-31.75-6T	80	60	31.75	50	7	12.4	6			
68400-04	HFM90-100-31.75-7T	100	78	31.75	50	8	14.4	7			
68400-05	HFM90-125-38.1-8T	125	89	38.1	63	9	16.4	8			
68400-06	HFM90-50-22-5T	50	48	22	40	6.3	10.4	5			
68400-07	HFM90-63-22-5T	63	48	22	40	6.3	10.4	5			
68400-08	HFM90-80-27-6T	80	60	27	50	7	12.4	6			
68400-09	HFM90-100-32-7T	100	78	32	50	8	14.4	7			
68400-10	HFM90-125-40-8T	125	89	40	63	9	16.4	8			

Coolant through design to reduce cutting wear.



Cutting Tool

68410

HDNX25°

Face Milling Cutter

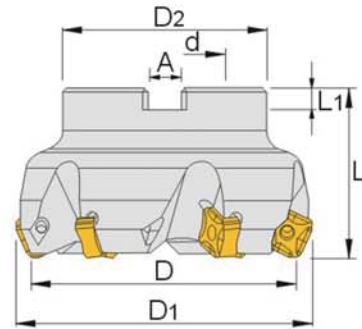

25° Unit:mm

Order No.	Model	D	D1	D2	d	L	L1	A	Flutes	Inserts	Wrench	Screw
68410-01	HDNX-080-25.4-6T	80	88	60	25.4	50	6	9.5	6	SNMT1205	T15	M4-12-5.7-60
68410-02	HDNX-100-31.75-7T	100	108	70	31.75	50	8	12.7	7			
68410-03	HDNX-125-38.1-8T	125	133	80	38.1	63	10	15.9	8			
68410-04	HDNX-160-50.8-10T	160	166	100	50.8	63	11	19	10			

Features:

1. Max. depth can be 8mm, increase efficiency.
2. Double side of insert can be used, for better effective.
3. Depending on processing needs, inserts and tools can be many options.
4. Better effect on casting iron, longer life-cycle.

HDNX Cutting Statics.

Unit:mm

ISO	Workpieces	Hardness(HB)	Vc(m/min)	Fz(mm/t)	Recommend Material
P	Carbon steel	180~280	150-175-200	0.10-0.15-0.20	ACP200
	Alloy steel	180~280	150-175-200	0.10-0.15-0.20	ACP200
K	Cast iron	250	150-225-300	0.10-0.20-0.30	ACK200,ACK300
	Nodular cast iron	250	150-200-250	0.10-0.18-0.25	ACK200,ACK300

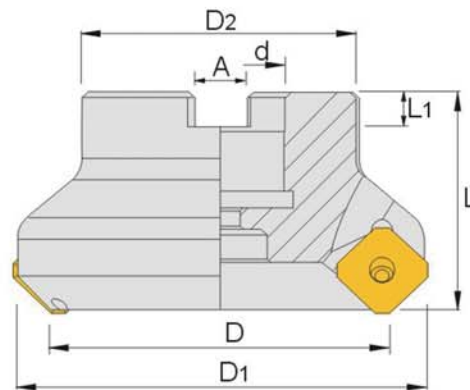

CUTTING TOOL

68420
ASX45°
45° Face Milling Cutter

45° Unit:mm

Order No.	Model	D	D1	D2	d	L	L1	A	Flutes	Inserts	Wrench	Screw
68420-01	ASX45-50-25.4-4T	50	63	48	25.4	40	6.3	10.4	4	SE□□13T3□□ (H)	T15	M3.5-10-5.5-60
68420-02	ASX45-63-25.4-5T	63	76	50	25.4	40	6.3	10.4	5			
68420-03	ASX45-80-31.75-6T	80	93	62	31.75	50	7	12.4	6			
68420-04	ASX45-100-31.75-7T	100	113	62	31.75	50	8	14.4	7			
68420-05	ASX45-125-38.1-8T	125	138	89	38.1	63	9	16.4	8			
68420-06	ASX45-50-22-4T	50	63	48	22	40	6.3	10.4	4			
68420-07	ASX45-63-22-5T	63	76	48	22	40	6.3	10.4	5			
68420-08	ASX45-80-27-6T	80	93	62	27	50	7	12.4	6			
68420-09	ASX45-100-32-7T	100	113	78	32	50	8	14.4	7			
68420-10	ASX45-125-40-8T	125	138	89	40	63	9	16.4	8			

Features:

1. Irregular distance design, better lifecycle and efficiency.
2. Precision work after heat treatment, better hardness and accuracy.
3. Coolant through design to reduce cutting tools wear.



CUTTING TOOL



Gin Tech Precision Co., Ltd. Copyrighted; All Rights Reserved

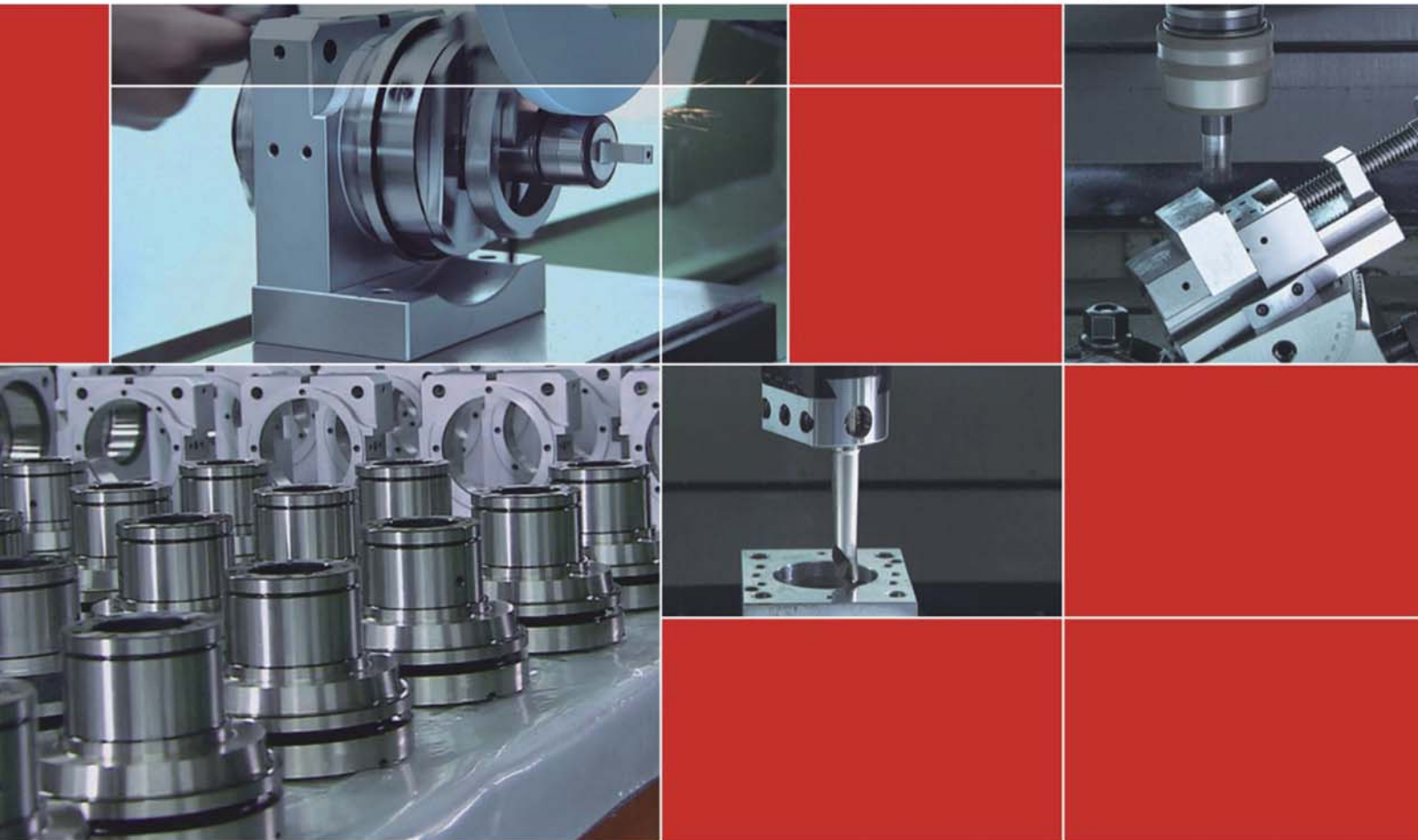

Gin Chan reserves right to amend the product content without prior notice

精展精密科技股份有限公司 (總公司) GIN TECH PRECISION CO.,LTD.

台灣238新北市樹林區保安街一段341巷7號
Address: No 7, Lane 341, Sec. 1, Bau An Street, Shu lin Dist.,
23841, New Taipei City, Taiwan
TEL: 886-2-2681-8596 (Rep.)  Sales@ginchan.com.tw
FAX: 886-2-2681-8516  www.ginchan.com.tw

大陸總經銷 東莞美商精展機械五金有限公司 東莞市精展機械五金有限公司 GIN CHAN MACHINERY & HARDWARE CO.,LTD.(DONGGUAN)

廣東省東莞市大朗鎮石廈村金沙崗二路27號
Tel: 86-769-8318-5858 (Rep.)
Fax: 86-769-8318-5838/8313-5003
 www.ginchan.com.cn  sales@ginchan.com.cn



Scan Now!

